



**OFFICE OF STATEWIDE HEALTH PLANNING AND DEVELOPMENT
FACILITIES DEVELOPMENT DIVISION**

**APPLICATION FOR OSHPD PREAPPROVAL
OF MANUFACTURER'S CERTIFICATION (OPM)**

OFFICE USE ONLY

APPLICATION #: OPM-0247-13

OSHPD Preapproval of Manufacturer's Certification (OPM)

Type: New Renewal Update to Pre-CBC 2013 OPA Number: _____

Manufacturer Information

Manufacturer: Pentair Equipment Protection

Manufacturer's Technical Representative: Nate Westby

Mailing Address: 2100 Hoffman Way, Anoka, MN. 55303

Telephone: (763) 422-2660 Email: Nate.westby@pentair.com

Product Information

Product Name: Free-Standing Enclosures – Single and Dual Access

Product Type: Communication Equipment

Product Model Number: Single Access: A602418FS, A722418FS, A723018FS, A723618FS, A902420FS, A903620FS, A603624FS, A722424FS, A723024FS, A723624FS, A903624FS, A723630FS, A723636FS, A903636FS

NOTE: Applies to all Single Access Enclosures
(no suffix - mild steel; 'G' suffix - mild steel painted; 'N4' suffix - stainless steel)

Dual Access:
A722424FSDA, A723024FSDA, A723624FSDA, A903624FSDA, A722430FSDA, A722436FSDA,
A723636FSDA, A903636FSDA

NOTE: Applies to all Dual Access Enclosures
(no suffix - mild steel; 'G' suffix - mild steel painted; 'N4' suffix - stainless steel)

General Description: Type 12 and Type 4X enclosures designed to hold electronic equipment in communication data centers and telecommunication rooms.

Applicant Information

Applicant Company Name: EASE Co.

Contact Person: Jonathan Roberson, S.E.

Mailing Address: 5877 Pine Ave. Suite 210, Chino Hills, CA. 91709

Telephone: (909) 606-7622 Email: J.Roberson@EASECo.com

I hereby agree to reimburse the Office of Statewide Health Planning and Development review fees in accordance with the California Administrative Code, 2013.

Signature of Applicant:  Date: 7/9/15

Title: Principal Engineer Company Name: EASE Co.

"Access to Safe, Quality Healthcare Environments that Meet California's Diverse and Dynamic Needs"

STATE OF CALIFORNIA – HEALTH AND HUMAN SERVICES AGENCY
OSH-FD-700 (REV 1/24/13)





**OFFICE OF STATEWIDE HEALTH PLANNING AND DEVELOPMENT
FACILITIES DEVELOPMENT DIVISION**

Registered Design Professional Preparing Engineering Recommendations

Company Name: EASE Co.

Name: Jonathan Roberson, S.E. California License Number: S4197

Mailing Address: 5877 Pine Ave. Suite 210, Chino Hills, CA. 91709

Telephone: 909-606-7667 Email: J.Roberson@EASECo.com

OSHPD Special Seismic Certification Preapproval (OSP)

- Special Seismic Certification is preapproved under OSP-
(Separate application for OSP is required)
- Special Seismic Certification is not preapproved

Certification Method(s)

- Testing in accordance with: ICC-ES AC156 FM 1950-10
- Other* (Please Specify): _____

*Use of test criteria other than those adopted by the California Building Standards Code, 2013 (CBSC 2013) for component supports and attachments are not permitted. For distribution system, interior partition wall, and suspended ceiling seismic bracings, test criteria other than those adopted in the CBSC 2013 may be used when approved by OSHPD prior to testing.

- Analysis
- Experience Data
- Combination of Testing, Analysis, and/or Experience Data (Please Specify): _____

List of Attachments Supporting the Manufacturer's Certification

- Test Report Drawings Calculations Manufacturer's Catalog
- Other(s) (Please Specify): _____

OFFICE USE ONLY – OSHPD APPROVAL VALID FOR CBC 2013 ONLY

Signature: *William Staehlin* Date: 10-14-2015

Print Name: William Staehlin

Title: SSE

Condition of Approval (if applicable): _____

"Access to Safe, Quality Healthcare Environments that Meet California's Diverse and Dynamic Needs"

STATE OF CALIFORNIA – HEALTH AND HUMAN SERVICES AGENCY
OSH-FD-700 (REV 1/24/13)





**EQUIPMENT ANCHORAGE
& SEISMIC ENGINEERING**

5877 Pine Ave, Ste. 210
Chino Hills, CA. 91709
Phn: (909) 606-7622

Office of Statewide Health Planning and Development
PREAPPROVAL OF MANUFACTURER'S CERTIFICATION
OPM-0247-13

THIS PREAPPROVAL CONFORMS TO THE 2013 CALIFORNIA BUILDING CODE

MANUFACTURER: **PENTAIR**
EQUIPMENT NAME: **FREE-STANDING ENCLOSURE-SINGLE & DUAL ACCESS**

Sheet: 1 of 18
Date: 10/6/15

GENERAL NOTES

1. THIS OSHPD PREAPPROVAL OF MANUFACTURER'S CERTIFICATION (OPM) IS BASED ON THE 2013 CBC. THE DEMANDS (DESIGN FORCES) FOR USE WITH THIS OPM SHALL BE BASED ON THE 2013 CBC
2. THIS DOCUMENT MAY ONLY BE USED WITH THE EXPRESS WRITTEN CONSENT OF THE MANUFACTURER LISTED ABOVE FOR THE SPECIFIC PROJECT SITE AND INSTALLATION LOCATION. THIS DOCUMENT IS INVALID WITHOUT SUCH CONSENT.
3. THIS PREAPPROVAL CONFORMS TO THE 2013 CALIFORNIA BUILDING CODE WHERE SDS IS NOT GREATER THAN 1.00, 1.15, 1.40, 1.50 & 2.20: SEE DETAILS FOR APPLICABILITY.
4. FORCES PER ASCE 7-10 SECTION 13.3.1, EQUATIONS 13.3-1, 13.3-2 & 13.3-3,
WHERE SDS = 1.00, $a_p = 2.5$, $l_p = 1.5$, $R_p = 6.0$, $z/h = 0$ AT CONCRETE SLAB. SEE FOLLOWING SHEETS FOR Ω
WHERE SDS = 1.15, $a_p = 2.5$, $l_p = 1.5$, $R_p = 6.0$, $z/h = 0$ AT CONCRETE SLAB. SEE FOLLOWING SHEETS FOR Ω
WHERE SDS = 1.40, $a_p = 2.5$, $l_p = 1.5$, $R_p = 6.0$, $z/h = 0$ AT CONCRETE SLAB. SEE FOLLOWING SHEETS FOR Ω
WHERE SDS = 1.50, $a_p = 2.5$, $l_p = 1.5$, $R_p = 6.0$, $z/h = 0$ AT CONCRETE SLAB. SEE FOLLOWING SHEETS FOR Ω
WHERE SDS = 2.20, $a_p = 2.5$, $l_p = 1.5$, $R_p = 6.0$, $z/h \leq 1$ AT CONCRETE SLAB ON METAL DECK. SEE FOLLOWING SHEETS FOR Ω .
5. THIS PREAPPROVAL COVERS ONLY THE SUPPORTS AND ATTACHMENTS OF THE EQUIPMENT TO THE STRUCTURE.
6. ALL DESIGN FORCES SHOWN ON THE DRAWINGS ARE FACTORED LOADS THAT SHALL BE USED FOR STRENGTH DESIGN.
7. CONCRETE SLAB ON METAL DECK DETAIL VALID FOR DEMANDS SHOWN AT ANY ELEVATION IN THE BUILDING. (i.e. $z/h \leq 1$)
8. CONCRETE SLAB ON GRADE DETAIL VALID FOR DEMANDS SHOWN AT ANY ELEVATION BELOW GRADE. (i.e. $z/h = 0$)
9. **RESPONSIBILITIES OF THE STRUCTURAL ENGINEER OF RECORD OF THE BUILDING**
 - A. PROVIDE SUPPORTING STRUCTURE TO SUPPORT WEIGHTS AND FORCES SHOWN IN ADDITION TO ALL OTHER LOADS.
 - B. VERIFY THAT THE INSTALLATION IS IN CONFORMANCE WITH THE 2013 CBC AND WITH THE DETAILS, MATERIAL AND GAGE OF THE UNIT WHERE ATTACHMENTS ARE MADE AGREE WITH THE INFORMATION SHOWN ON THE PREAPPROVAL DOCUMENTS.
 - C. VERIFY THAT PROJECT SPECIFIC VALUES OF SDS & z/h RESULT IN SEISMIC FORCES (E_h , E_v) THAT DO NOT EXCEED THE VALUES ON THE DETAILS.
 - D. VERIFY THAT THE CONCRETE SLAB TO WHICH THE EQUIPMENT IS ANCHORED MEETS THE REQUIREMENTS OF THE APPLICABLE ICC ESR.
 - E. VERIFY THAT THE ANCHORS ARE AN ADEQUATE DISTANCE FROM ANY SLAB EDGES OR OPENINGS (SEE TYPICAL DETAIL ON SHEET 2).
 - F. VERIFY THAT ALL NEW OR EXISTING ANCHORS ARE AN ADEQUATE DISTANCE FROM THE UNIT ATTACHMENTS AND CHECK FOR INTERACTION WHERE OTHER ANCHORS ARE WITHIN 18" OR $6h_{ef}$ FROM THIS UNIT'S ANCHORS.
 - G. EQUIPMENT MANUFACTURER MUST DESIGN UNIT TO MAKE C.G. \leq THAN THE C.G. HEIGHT DIMENSION SHOWN ON DRAWINGS.
 - H. ALL HOLES THRU STEEL FOR BOLTS SHALL BE STANDARD HOLE SIZE PER ANSI/AISC 360-10 TABLE J3.3.



PENTAIR

FREE-STANDING ENCLOSURE SINGLE & DUAL ACCESS

DES. **J. ROBERSON**

JOB NO. **11-1461**

DATE **10/6/15**

SHEET

2

OF **18** SHEETS

10. EXPANSION ANCHORS:

A. ATTACHMENT IS TO BE MADE WITH THE ANCHORS LISTED BELOW AND INSTALLED AS DESCRIBED IN THE CORRESPONDING ICC REPORT.

Anchor Diameter	Concrete Type	Min. f'c (psi)	Anchor Type	ICC Report No.	Min. Embed.	Min. Spacing	Min. Edge Dist.	Min. Conc. Thickness	Torque Test	Direct Tension Test
3/8"	Sand Light Weight	3000	Hilti Kwik Bolt TZ	ESR-1917	2"	N/A	N/A	See Sheet 16 of 18	25 FT-LB	1186 lb
5/8"	Normal Weight	3000	Hilti Kwik Bolt TZ	ESR-1917	3-1/8"	12"	24"	5"	60 FT-LB	3135 lb
5/8"	Normal Weight	3000	Hilti Kwik Bolt TZ	ESR-1917	4"	12"	24"	6"	60 FT-LB	4540 lb

B. THIS PREAPPROVAL ALLOWS FOR UP TO A MAXIMUM OF 2 ADJACENT CONCRETE SLAB EDGES, 24" AWAY MINIMUM (i.e. - CORNER). SEE ADJACENT DETAIL FOR ADDITIONAL MINIMUM ALLOWABLE CONCRETE EDGE DISTANCES.

C. TESTING OF EXPANSION ANCHORS PER 2013 CBC, 1913A.7: TESTING SHALL BE DONE IN THE PRESENCE OF THE SPECIAL INSPECTOR AND A REPORT OF THE TEST RESULTS SHALL BE SUBMITTED TO OSHPD

(i) AFTER AT LEAST 24 HOURS HAVE ELAPSED SINCE INSTALLATION, DIRECT PULL TENSION TEST OR TORQUE TEST AT LEAST 50% OF THE ANCHORS.

(ii) ACCEPTANCE CRITERIA:

- DIRECT TENSION TEST: THE ANCHOR SHOULD HAVE NO OBSERVABLE MOVEMENT AT THE TEST LOAD. A PRACTICAL WAY TO DETERMINE OBSERVABLE MOVEMENT IS THAT THE WASHER BECOMES LOOSE.
- TORQUE TEST: THE APPLICABLE TORQUE MUST BE ACHIEVED WITHIN THE FOLLOWING LIMITS: WEDGE TYPE : 1/2 TURN OF THE NUT

(iii) IF ANY ANCHOR FAILS, TEST ALL ANCHORS.

D. AVOID DAMAGING EXISTING STEEL REINFORCING IN CONCRETE SLAB WHEN INSTALLING CONCRETE EXPANSION ANCHORS.

E. PROVIDE FOR FULL THREAD ENGAGEMENT OF NUT & WASHER.

11. BOLTS THROUGH CONCRETE ON METAL DECK

- A. BOLTS SHALL BE TORQUED BY 3/4 TURN OF THE NUTS AFTER THE SNUG TIGHT (THE SNUG-TIGHT CONDITION IS DEFINED AS THE TIGHTNESS REQUIRED TO BRING THE CONNECTED PLIES INTO FIRM CONTACT) CONDITION IS ACHIEVED, UNLESS OTHERWISE NOTED.
- B. THROUGH BOLT HOLES SHALL BE 1/16" LARGER THAN BOLT SIZE (HOLE SIZE = BOLT SIZE + 1/16) FOR CONCRETE.
- C. THROUGH-BOLTS IN CONCRETE SHALL RECEIVE SPECIAL INSPECTION AND TESTING (THROUGH BOLTS WITH STEEL TO STEEL CONNECTION IN TENSION DO NOT REQUIRE TENSION TESTING) IN ACCORDANCE WITH REQUIREMENTS FOR POST-INSTALLED ANCHORS.

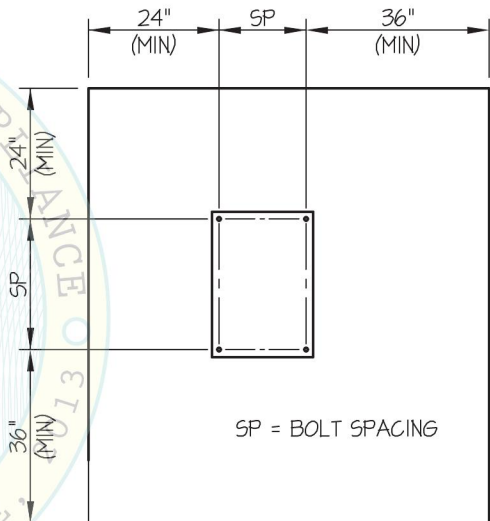

TYPICAL CONCRETE EDGE DETAIL



PENTAIR

FREE-STANDING ENCLOSURE SINGLE ACCESS

DES. **J. ROBERSON**

JOB NO. **11-1461**

DATE **10/6/15**

SHEET

3

OF **18** SHEETS

SEISMIC SUPPORTS & ATTACHMENTS

CONCRETE SLAB

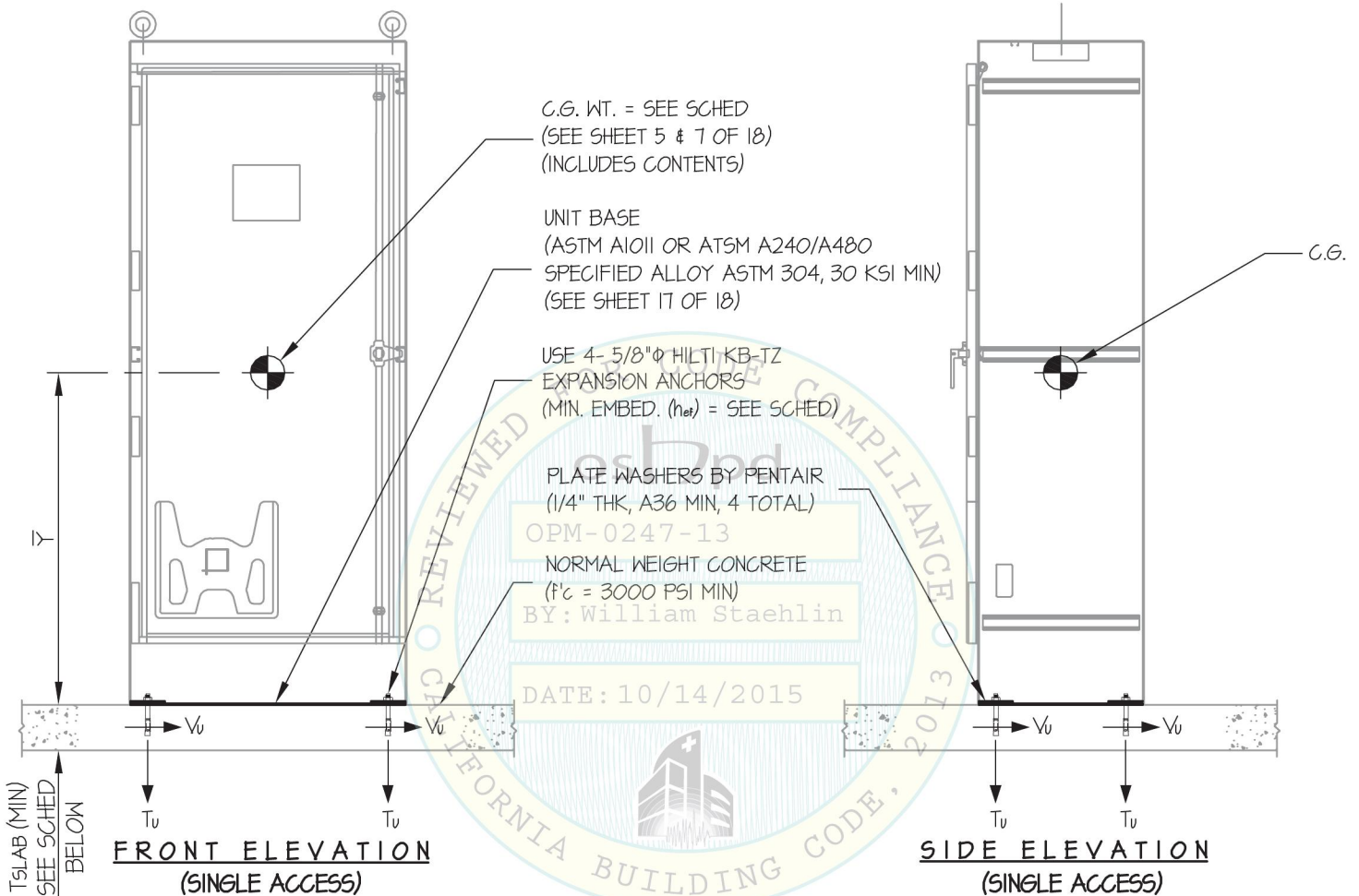

ANCHORS

MAX Sds	TYPE	DIAM	EFF EMBED	QTY	TSLAB
100	HILTI KB-TZ	5/8"	3.125"	4	5"
140	HILTI KB-TZ	5/8"	4"	4	6"

NOTES:

- FORCES ARE DETERMINED PER 2013 CALIFORNIA BUILDING CODE AND ASCE 7-10. STRENGTH DESIGN IS USED. ($\alpha_p = 2.5$, $l_p = 1.5$, $R_p = 6.0$, $\Omega_0 = 2.5$, $z/h = 0$)
- CENTER OF GRAVITY (C.G.) AND WEIGHT ARE THE GOVERNING PARAMETERS FOR DESIGN. THIS PREAPPROVAL ENCOMPASSES ALL WEIGHTS UP TO THE MAXIMUM WEIGHT SHOWN.
- STRUCTURAL ENGINEER OF RECORD FOR THE BUILDING SHALL PROVIDE SUPPORT STRUCTURE DESIGNED TO SUPPORT WEIGHTS AND FORCES SHOWN IN COMBINATION WITH ALL OTHER LOADS THAT MAY BE PRESENT.



PENTAIR

FREE-STANDING ENCLOSURE SINGLE ACCESS

DES. J. ROBERSON

JOB NO. 11-1461

DATE 10/6/15

SHEET

4

OF 18 SHEETS

SEISMIC SUPPORTS & ATTACHMENTS

MAX $S_{ps} \leq 1.00$

CONCRETE SLAB

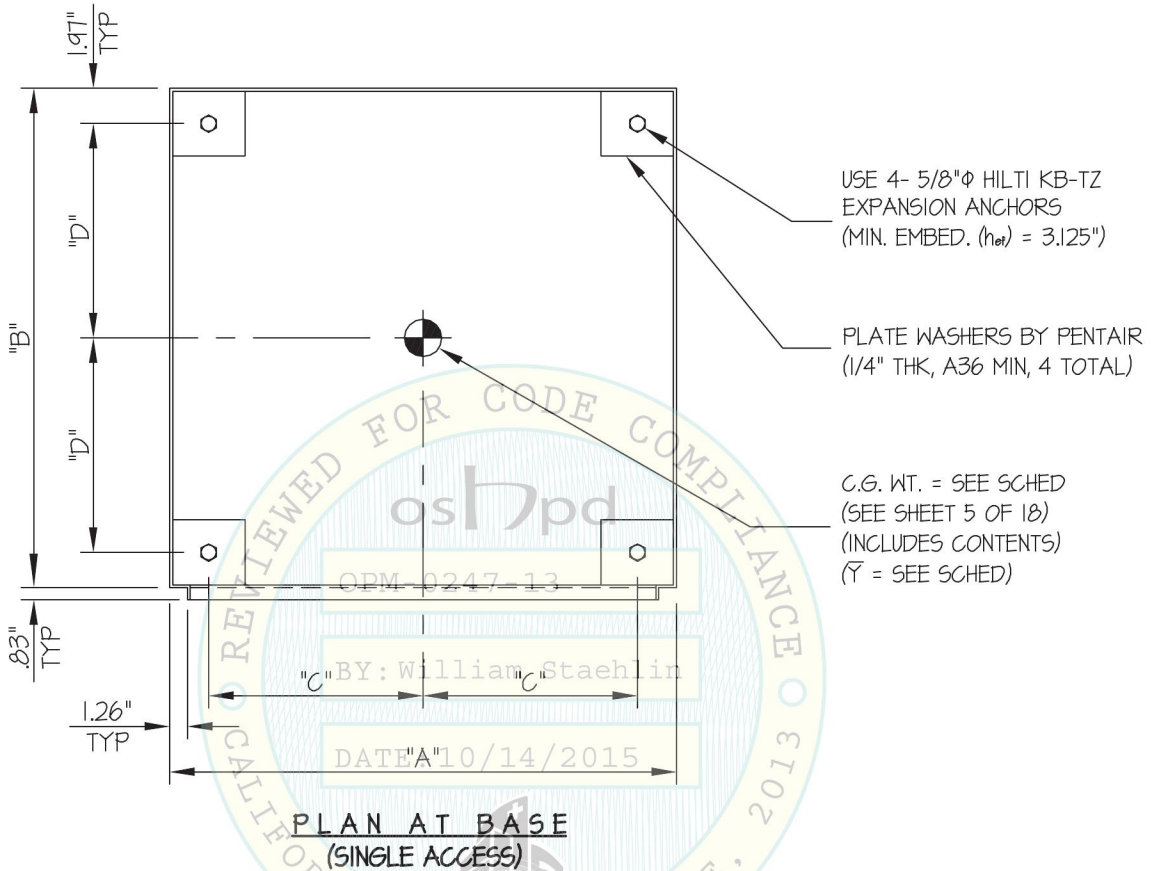

PENTAIR

FREE-STANDING ENCLOSURE SINGLE ACCESS

DES. **J. ROBERSON**

JOB NO. **11-1461**

DATE **10/6/15**

SHEET

5

OF **18** SHEETS

SEISMIC SUPPORTS & ATTACHMENTS

MAX Sps ≤ 1.00

CONCRETE SLAB

FREE-STANDING SINGLE ACCESS

MODEL	EMPTY CAB WEIGHT (lb)	WEIGHT (lb) INCLUDES CONTENTS	Y (in.)	"A" (in.)	"B" (in.)	"C" (in.)	"D" (in.)	** Tu (lb.)	** Vu (lb.)
A602418FS	234	1234	30.03	24.06	18.06	10.06	7.06	1579	349
A722418FS	262	1262	36.03	24.06	18.06	10.06	7.06	1982	357
A723018FS	298	1298	36.03	30.06	18.06	13.06	7.06	1948	367
A723618FS	335	1335	36.03	36.06	18.06	16.06	7.06	1945	377
A902420FS	328	1328	45.03	24.06	20.06	10.06	8.06	2367	375
A903620FS	409	1409	45.03	36.06	20.06	16.06	8.06	2312	398
A603624FS	336	1336	30.03	36.06	24.06	16.06	10.06	1105	377
A722424FS	306	1306	36.03	24.06	24.06	10.06	10.06	1489	369
A723024FS	343	1343	36.03	30.06	24.06	13.06	10.06	1438	379
A723624FS	376	1376	36.03	36.06	24.06	16.06	10.06	1413	389
A903624FS	446	1446	45.03	36.06	24.06	16.06	10.06	1919	408
A723630FS	424	1424	36.03	36.06	30.06	16.06	13.06	1131	402
A723636FS	469	1469	36.03	36.06	36.06	16.06	16.06	953	415
A903636FS	550	1550	45.03	36.06	36.06	16.06	16.06	1325	438

** VALUES INCLUDE Ω .



PENTAIR

FREE-STANDING ENCLOSURE SINGLE ACCESS

DES. **J. ROBERSON**

JOB NO. **11-1461**

DATE **10/6/15**

SHEET

6

OF **18** SHEETS

SEISMIC SUPPORTS & ATTACHMENTS

1.00 < MAX S DS ≤ 1.40

CONCRETE SLAB ON METAL DECK

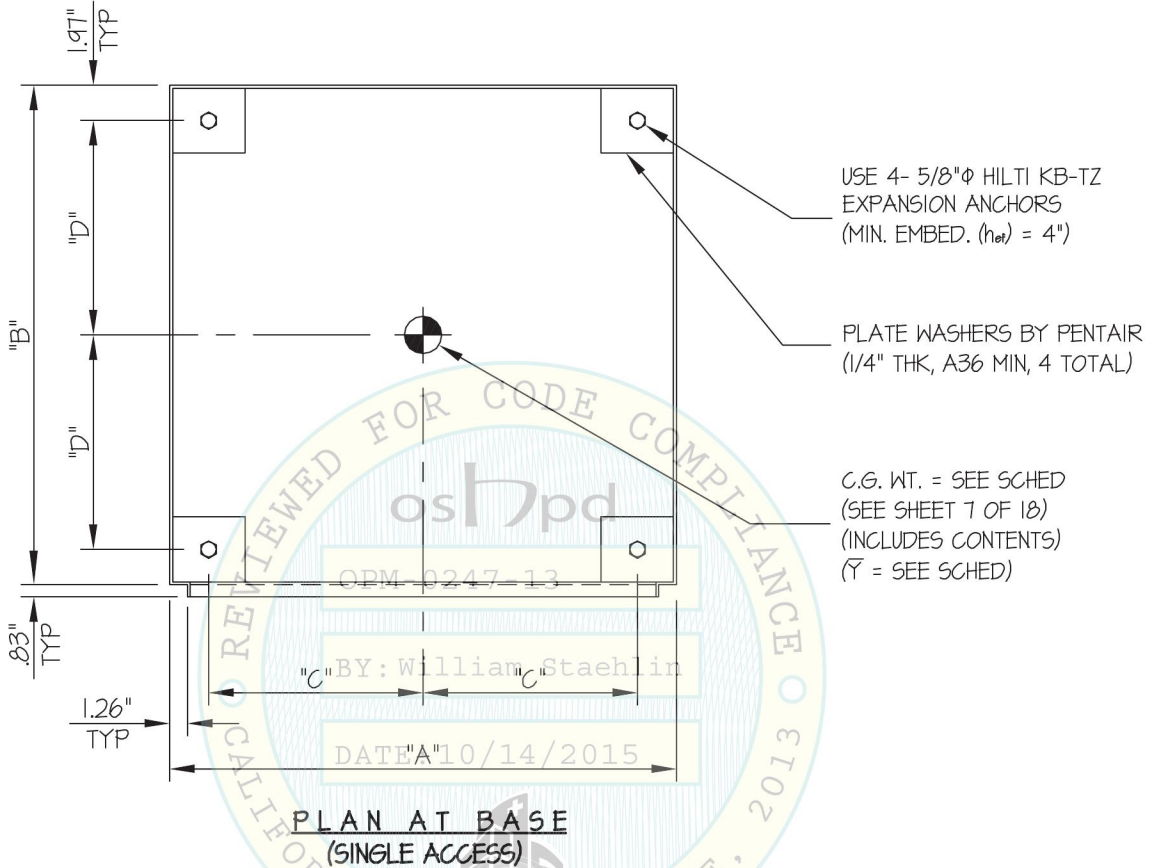

Jonathan Roberson

REGISTERED PROFESSIONAL ENGINEER
No. 4197
EXP. 6-30-2016
10/6/15
STRUCTURAL
STATE OF CALIFORNIA

PENTAIR

FREE-STANDING ENCLOSURE SINGLE ACCESS

DES. **J. ROBERSON**

JOB NO. **11-1461**

DATE **10/6/15**

SHEET

7

OF **18** SHEETS

SEISMIC SUPPORTS & ATTACHMENTS

1.00 < MAX S DS ≤ 1.40

CONCRETE SLAB ON METAL DECK

FREE-STANDING SINGLE ACCESS

MODEL	EMPTY CAB WEIGHT (lb.)	WEIGHT (lb.) INCLUDES CONTENTS	Ȳ (in.)	"A" (in.)	"B" (in.)	"C" (in.)	"D" (in.)	** Tu (lb.)	** Vu (lb.)
A602418FS	234	1234	30.03	24.06	18.06	10.06	7.06	2319	487
A722418FS	262	1262	36.03	24.06	18.06	10.06	7.06	2884	498
A723018FS	298	1298	36.03	30.06	18.06	13.06	7.06	2840	513
A723618FS	335	1335	36.03	36.06	18.06	16.06	7.06	2839	527
A902420FS	328	1328	45.03	24.06	20.06	10.06	8.06	3429	525
A903620FS	409	1409	45.03	36.06	20.06	16.06	8.06	3359	557
A603624FS	336	1336	30.03	36.06	24.06	16.06	10.06	1664	528
A722424FS	306	1306	36.03	24.06	24.06	10.06	10.06	2199	516
A723024FS	343	1343	36.03	30.06	24.06	13.06	10.06	2131	530
A723624FS	376	1376	36.03	36.06	24.06	16.06	10.06	2099	544
A903624FS	446	1446	45.03	36.06	24.06	16.06	10.06	2813	571
A723630FS	424	1424	36.03	36.06	30.06	16.06	13.06	1710	562
A723636FS	469	1469	36.03	36.06	36.06	16.06	16.06	1465	580
A903636FS	550	1550	45.03	36.06	36.06	16.06	16.06	1991	612

** VALUES INCLUDE Ω.



PENTAIR

FREE-STANDING ENCLOSURE DUAL ACCESS

DES. **J. ROBERSON**

JOB NO. **11-1461**

DATE **10/6/15**

SHEET

8

OF **18** SHEETS

SEISMIC SUPPORTS & ATTACHMENTS

CONCRETE DETAILS

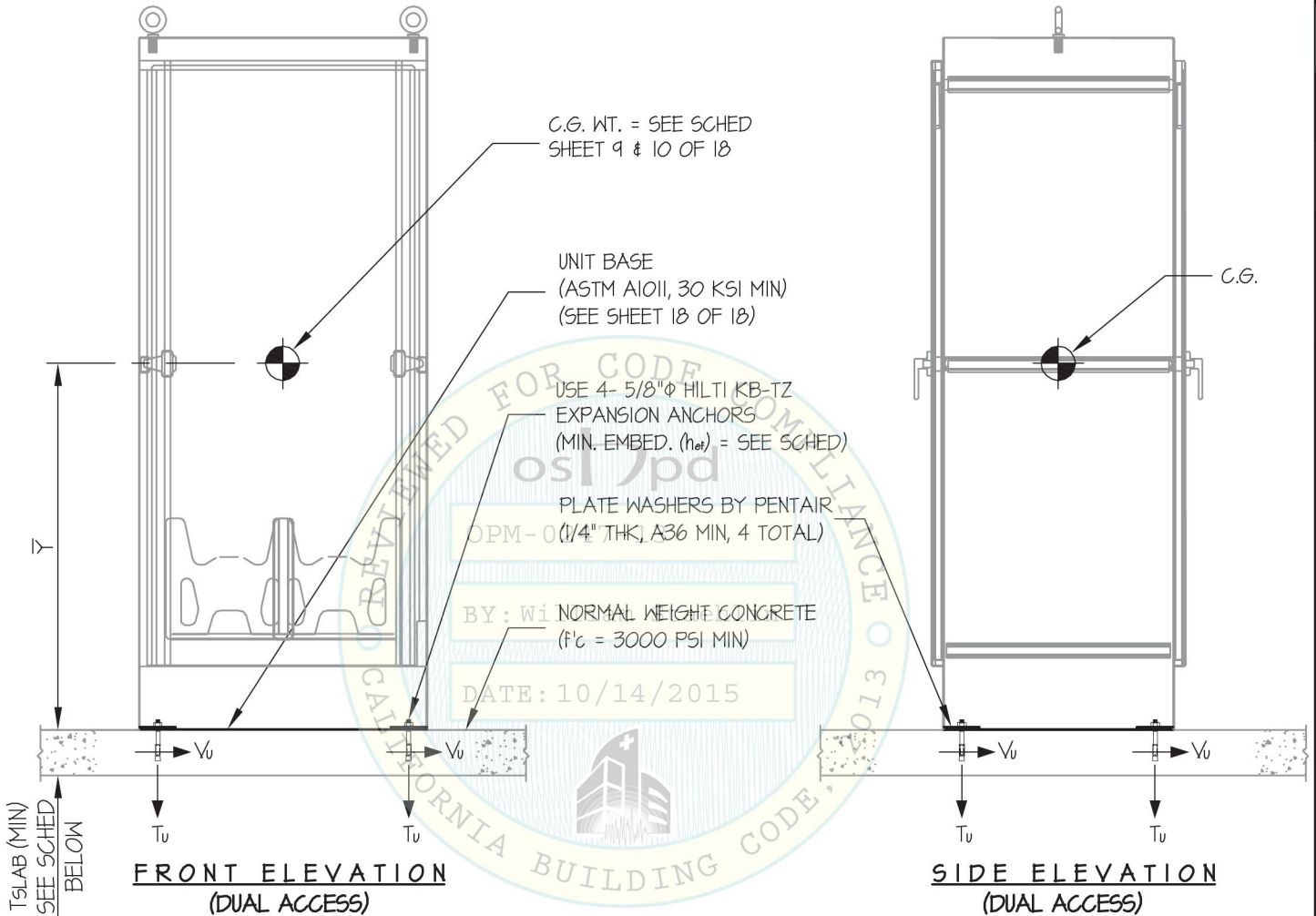

ANCHORS					
MAX Sds	TYPE	DIAM	EFF EMBED	QTY	T _{SLAB}
115	HILTI KB-TZ	5/8"	3.125"	4	5"
150	HILTI KB-TZ	5/8"	4"	4	6"

NOTES:

- FORCES ARE DETERMINED PER 2013 CALIFORNIA BUILDING CODE AND ASCE 7-10. STRENGTH DESIGN IS USED. ($\alpha_p = 2.5$, $l_p = 1.5$, $R_p = 6.0$, $\Omega_o = 2.5$, $z/h = 0$)
- CENTER OF GRAVITY (C.G.) AND WEIGHT ARE THE GOVERNING PARAMETERS FOR DESIGN. THIS PREAPPROVAL ENCOMPASSES ALL WEIGHTS UP TO THE MAXIMUM WEIGHT SHOWN.
- STRUCTURAL ENGINEER OF RECORD FOR THE BUILDING SHALL PROVIDE SUPPORT STRUCTURE DESIGNED TO SUPPORT WEIGHTS AND FORCES SHOWN IN COMBINATION WITH ALL OTHER LOADS THAT MAY BE PRESENT.



PENTAIR

FREE-STANDING ENCLOSURE DUAL ACCESS

DES. **J. ROBERSON**

JOB NO. **11-1461**

DATE **10/6/15**

SHEET

9

OF **18** SHEETS

SEISMIC SUPPORTS & ATTACHMENTS

MAX $S_{ps} \leq 1.15$

BRACKET DETAILS

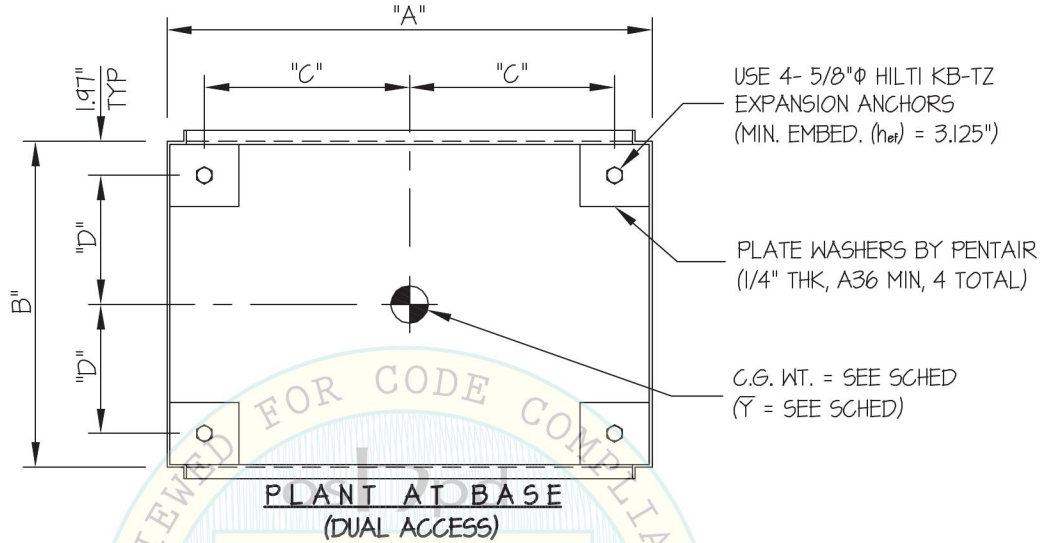

OPM-0247-13

UNIT NUMBER	EMPTY CAB WEIGHT (lb.)	WEIGHT (lb.) INCLUDES CONTENTS	\bar{Y} (in.)	"A" (in.)	"B" (in.)	"C" (in.)	"D" (in.)	* T_u (lb.)	* V_u (lb.)
A722424FSDA	324	1324	36.03	24.06	24.06	10.06	10.06	1766	427
A723024FSDA	361	1361	36.03	30.06	24.06	13.06	10.06	1707	439
A723624FSDA	396	1396	36.03	36.06	24.06	16.06	10.06	1682	450
A903624FSDA	472	1472	45.03	36.06	24.06	16.06	10.06	2278	475
A722430FSDA	366	1366	36.03	24.06	30.06	10.06	13.06	1714	441
A722436FSDA	409	1409	36.03	24.06	36.06	10.06	16.06	1697	454
A723636FSDA	488	1488	36.03	36.06	36.06	16.06	16.06	1150	480
A903636FSDA	568	1568	45.03	36.06	36.06	16.06	16.06	1581	506

* VALUES INCLUDE Ω .



PENTAIR

FREE-STANDING ENCLOSURE DUAL ACCESS

DES. **J. ROBERSON**

JOB NO. **11-1461**

DATE **10/6/15**

SHEET

10

OF **18** SHEETS

SEISMIC SUPPORTS & ATTACHMENTS

1.15 < MAX S_{Ds} ≤ 1.50

CONCRETE SLAB

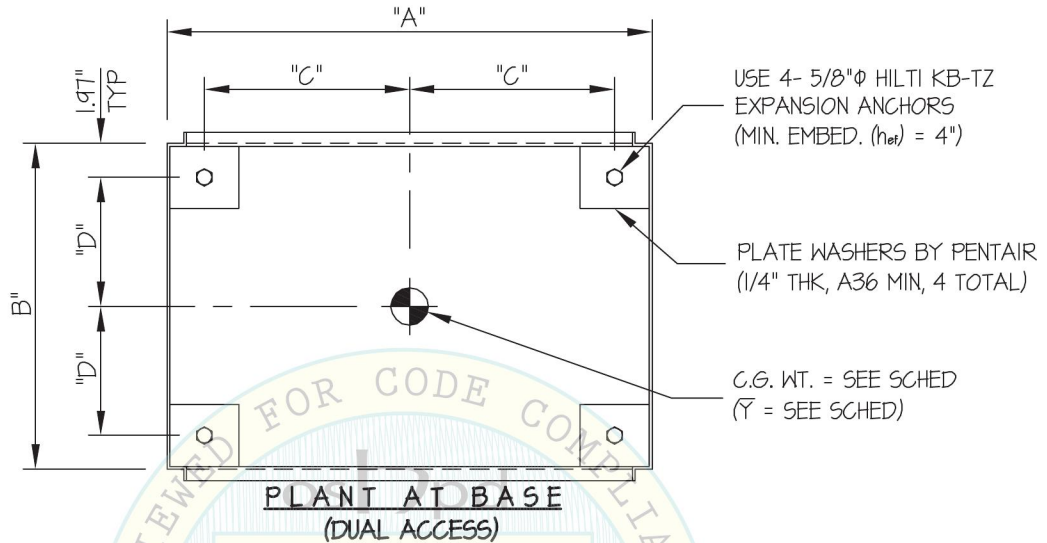

OPM-0247-13

UNIT NUMBER	EMPTY CAB WEIGHT (lb)	WEIGHT (lb) INCLUDES CONTENTS	\bar{Y} (in)	"A" (in)	"B" (in)	"C" (in)	"D" (in)	* T_u (lb)	* V_u (lb)
A722424FSDA	324	1324	36.03	24.06	24.06	10.06	10.06	2406	559
A723024FSDA	361	1361	36.03	30.06	24.06	13.06	10.06	2331	575
A723624FSDA	396	1396	36.03	36.06	24.06	16.06	10.06	2300	590
A903624FSDA	472	1472	45.03	36.06	24.06	16.06	10.06	3086	622
A722430FSDA	366	1366	36.03	24.06	30.06	10.06	13.06	2340	577
A722436FSDA	409	1409	36.03	24.06	36.06	10.06	16.06	2321	595
A723636FSDA	488	1488	36.03	36.06	36.06	16.06	16.06	1610	629
A903636FSDA	568	1568	45.03	36.06	36.06	16.06	16.06	2180	662

* VALUES INCLUDE Ω .



PENTAIR

FREE-STANDING ENCLOSURE SINGLE ACCESS

DES. **J. ROBERSON**

SHEET

11

JOB NO. **11-1461**

DATE **10/6/15**

OF **18** SHEETS

SEISMIC SUPPORTS & ATTACHMENTS

CONCRETE SLAB ON METAL DECK

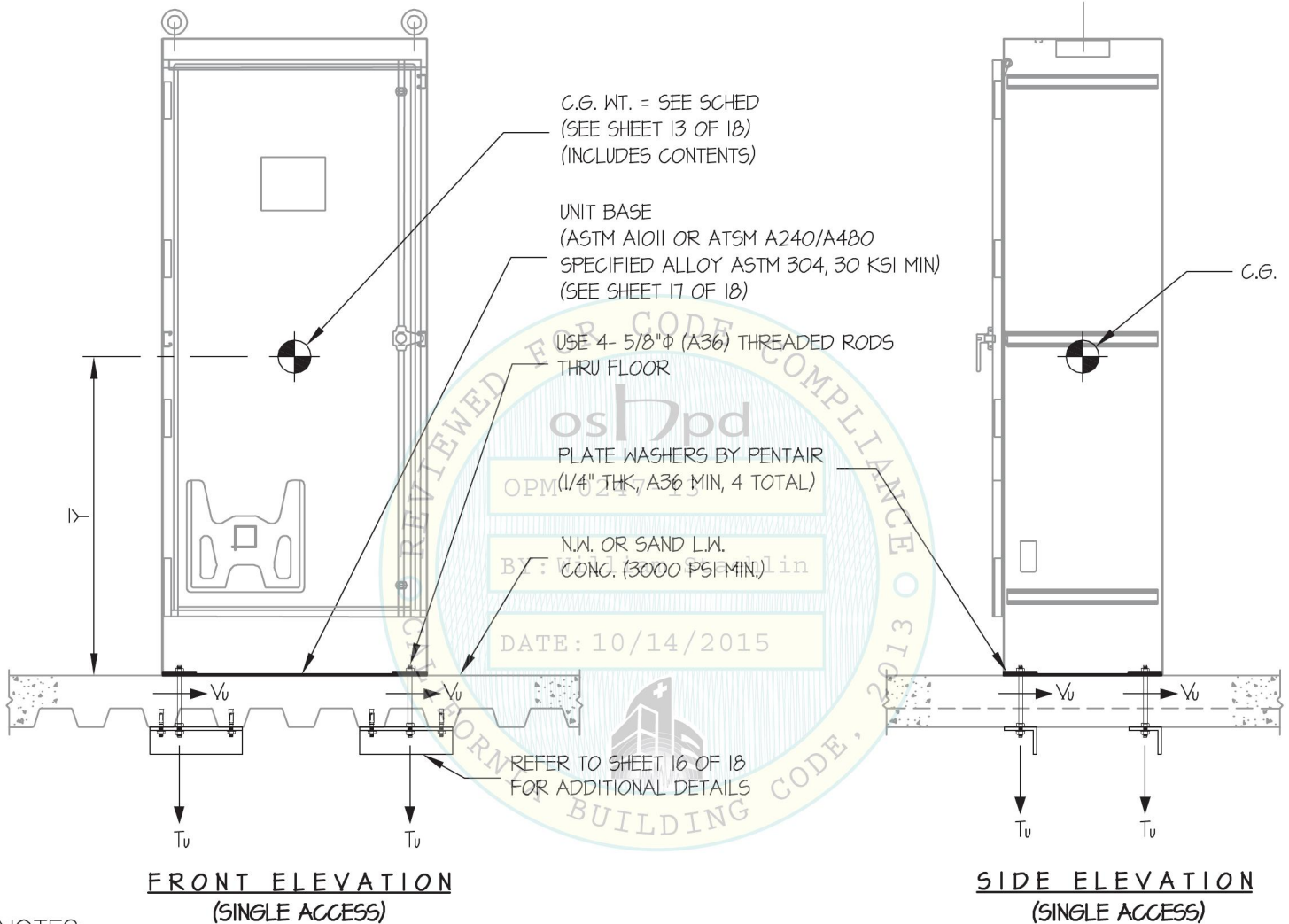

NOTES:

- FORCES ARE DETERMINED PER 2013 CALIFORNIA BUILDING CODE AND ASCE 7-10. STRENGTH DESIGN IS USED. ($S_Ds = 2.20$, $a_p = 2.5$, $l_p = 1.5$, $R_p = 6.0$, $\Omega_o = 2.5$, $z/h \leq 1$)

 HORIZONTAL FORCE (E_h) = $1.65 W_p$
 HORIZONTAL FORCE (E_{mh}) = $4.13 W_p$ (FOR CONCRETE ANCHORAGE)
 VERTICAL FORCE (E_v) = $0.44 W_p$
- CENTER OF GRAVITY (C.G.) AND WEIGHT ARE THE GOVERNING PARAMETERS FOR DESIGN. THIS PREAPPROVAL ENCOMPASSES ALL WEIGHTS UP TO THE MAXIMUM WEIGHT SHOWN.
- STRUCTURAL ENGINEER OF RECORD FOR THE BUILDING SHALL PROVIDE SUPPORT STRUCTURE DESIGNED TO SUPPORT WEIGHTS AND FORCES SHOWN IN COMBINATION WITH ALL OTHER LOADS THAT MAY BE PRESENT.

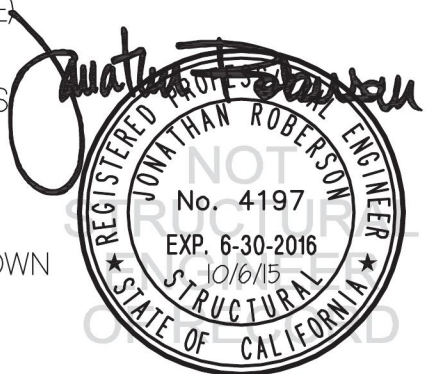

PENTAIR

FREE-STANDING ENCLOSURE SINGLE ACCESS

DES. **J. ROBERSON**

JOB NO. **11-1461**

DATE **10/6/15**

SHEET

12

OF **18** SHEETS

SEISMIC SUPPORTS & ATTACHMENTS

CONCRETE SLAB ON METAL DECK

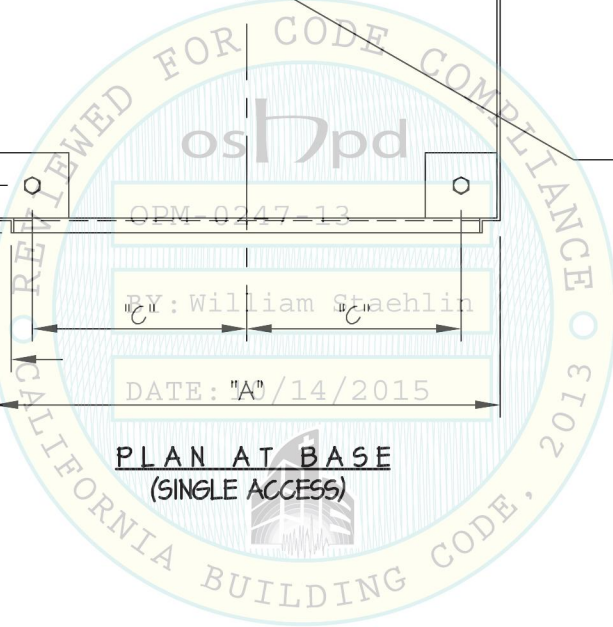
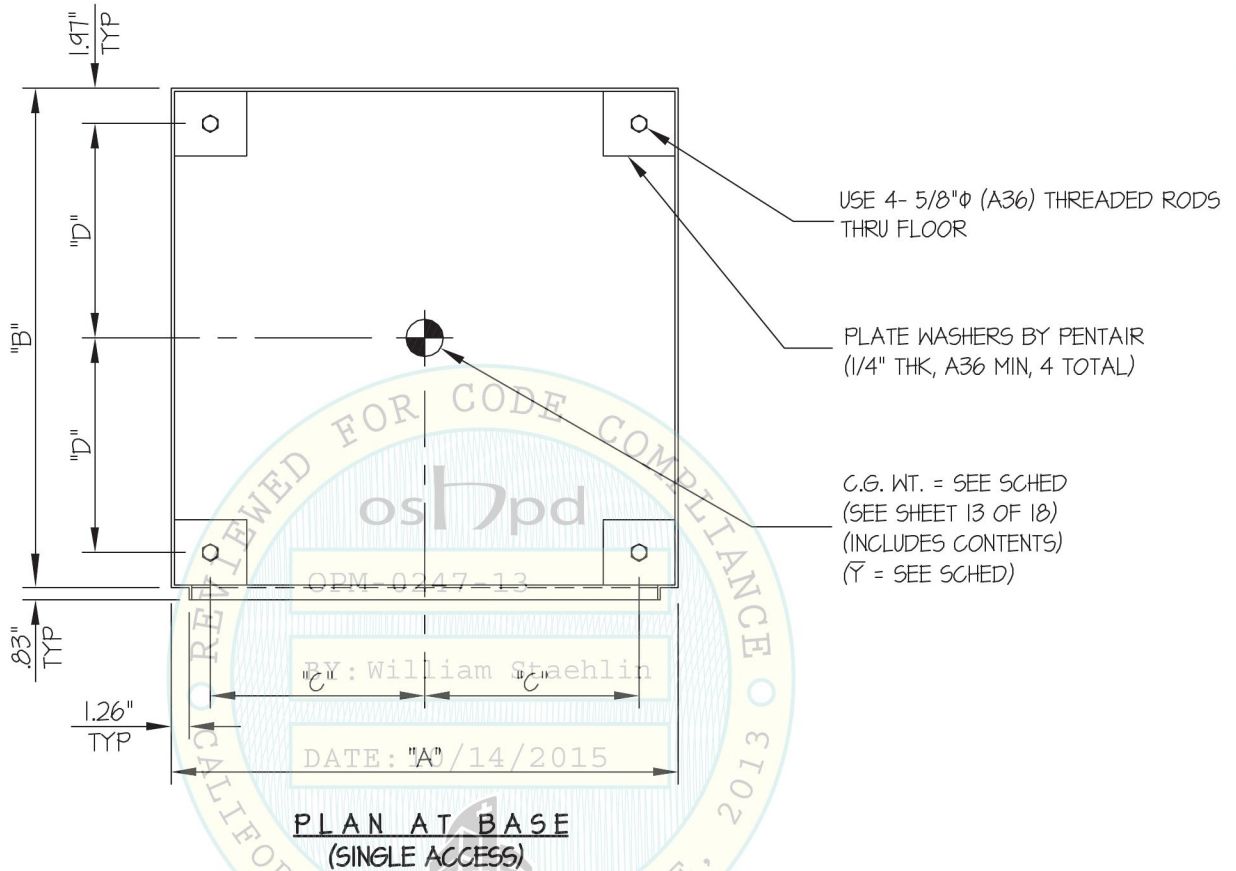

PENTAIR

FREE-STANDING ENCLOSURE SINGLE ACCESS

DES. **J. ROBERSON**

JOB NO. **11-1461**

DATE **10/6/15**

SHEET

13

OF **18** SHEETS

SEISMIC SUPPORTS & ATTACHMENTS

CONCRETE SLAB ON METAL DECK

FREE-STANDING SINGLE ACCESS

MODEL	EMPTY CAB WEIGHT (lb)	WEIGHT (lb) INCLUDES CONTENTS	Y (in.)	"A" (in.)	"B" (in.)	"C" (in.)	"D" (in.)	** Tu (lb.)	** Vu (lb.)
A602418FS	234	1234	30.03	24.06	18.06	10.06	7.06	2479	509
A722418FS	262	1262	36.03	24.06	18.06	10.06	7.06	3071	521
A723018FS	298	1298	36.03	30.06	18.06	13.06	7.06	3026	535
A723618FS	335	1335	36.03	36.06	18.06	16.06	7.06	3027	551
A902420FS	328	1328	45.03	24.06	20.06	10.06	8.06	3643	548
A903620FS	409	1409	45.03	36.06	20.06	16.06	8.06	3574	581
A603624FS	336	1336	30.03	36.06	24.06	16.06	10.06	1801	551
A722424FS	306	1306	36.03	24.06	24.06	10.06	10.06	2358	539
A723024FS	343	1343	36.03	30.06	24.06	13.06	10.06	2288	554
A723624FS	376	1376	36.03	36.06	24.06	16.06	10.06	2257	568
A903624FS	446	1446	45.03	36.06	24.06	16.06	10.06	3005	596
A723630FS	424	1424	36.03	36.06	30.06	16.06	13.06	1852	587
A723636FS	469	1469	36.03	36.06	36.06	16.06	16.06	1598	606
A903636FS	550	1550	45.03	36.06	36.06	16.06	16.06	2152	639

** VALUES DO NOT INCLUDE Ω .



PENTAIR

FREE-STANDING ENCLOSURE DUAL ACCESS

DES. **J. ROBERSON**

JOB NO. **11-1461**

DATE **10/6/15**

SHEET

14

OF **18** SHEETS

SEISMIC SUPPORTS & ATTACHMENTS

CONCRETE SLAB ON METAL DECK

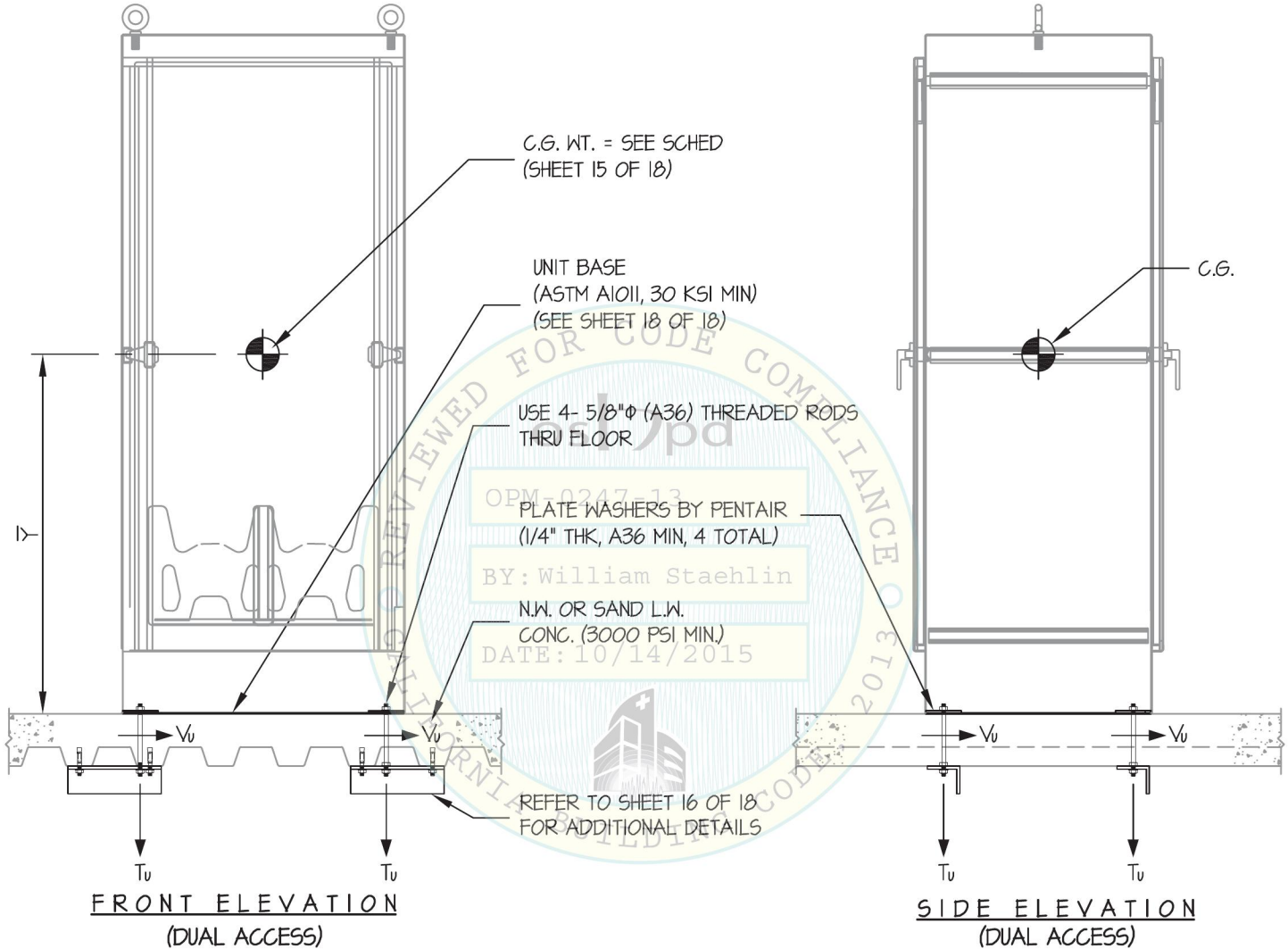

NOTES:

- FORCES ARE DETERMINED PER 2013 CALIFORNIA BUILDING CODE AND ASCE 7-10. STRENGTH DESIGN IS USED. ($S_Ds = 2.20$, $a_p = 2.5$, $I_p = 1.5$, $R_p = 6.0$, $\Omega_o = 2.5$, $z/h \leq 1$)

HORIZONTAL FORCE (E_h) = $1.65 W_p$

HORIZONTAL FORCE (E_{mh}) = $4.13 W_p$ (FOR CONCRETE ANCHORAGE)

VERTICAL FORCE (E_v) = $0.44 W_p$

- CENTER OF GRAVITY (C.G.) AND WEIGHT ARE THE GOVERNING PARAMETERS FOR DESIGN. THIS PREAPPROVAL ENCOMPASSES ALL WEIGHTS UP TO THE MAXIMUM WEIGHT SHOWN.
- STRUCTURAL ENGINEER OF RECORD FOR THE BUILDING SHALL PROVIDE SUPPORT STRUCTURE DESIGNED TO SUPPORT WEIGHTS AND FORCES SHOWN IN COMBINATION WITH ALL OTHER LOADS THAT MAY BE PRESENT.

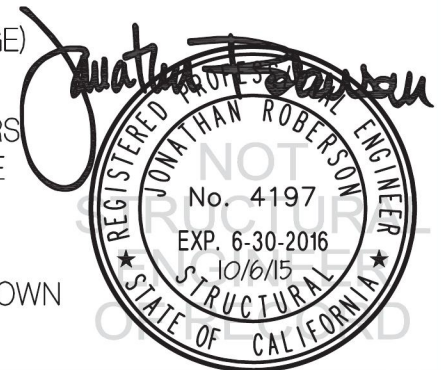

PENTAIR

FREE-STANDING ENCLOSURE DUAL ACCESS

DES. **J. ROBERSON**

JOB NO. **11-1461**

DATE **10/6/15**

SHEET

15

OF **18** SHEETS

SEISMIC SUPPORTS & ATTACHMENTS

CONCRETE SLAB ON METAL DECK

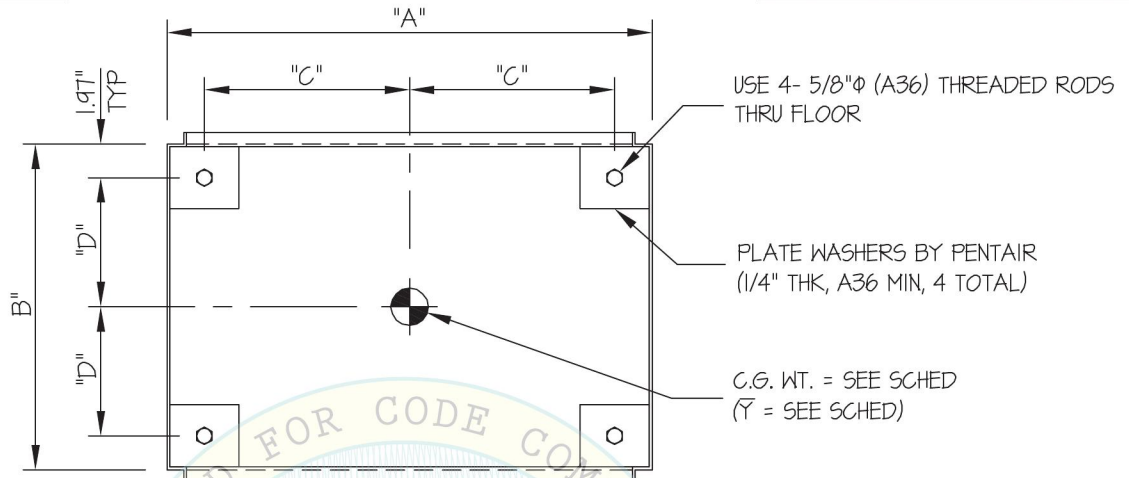

**PLANT AT BASE
(DUAL ACCESS)**

OPM-0247-13

UNIT NUMBER	EMPTY CAB WEIGHT (lb.)	WEIGHT (lb.) INCLUDES CONTENTS	\bar{Y} (in.)	"A" (in.)	"B" (in.)	"C" (in.)	"D" (in.)	* Tu (lb.)	* Vu (lb.)
A722424FSDA	324	1324	36.03	24.06	24.06	10.06	10.06	2391	546
A723024FSDA	361	1361	36.03	30.06	24.06	13.06	10.06	2319	561
A723624FSDA	396	1396	36.03	36.06	24.06	16.06	10.06	2289	576
A903624FSDA	472	1472	45.03	36.06	24.06	16.06	10.06	3059	607
A722430FSDA	366	1366	36.03	24.06	30.06	10.06	13.06	2327	563
A722436FSDA	409	1409	36.03	24.06	36.06	10.06	16.06	2311	581
A723636FSDA	488	1488	36.03	36.06	36.06	16.06	16.06	1619	614
A903636FSDA	568	1568	45.03	36.06	36.06	16.06	16.06	2177	647

* VALUES DO NOT INCLUDE Ω .



PENTAIR

FREE-STANDING ENCLOSURE SINGLE & DUAL ACCESS

DES. **J. ROBERSON**

JOB NO. **11-1461**

DATE **10/6/15**

SHEET

16

OF **18** SHEETS

SEISMIC SUPPORTS & ATTACHMENTS

BRACKET DETAILS

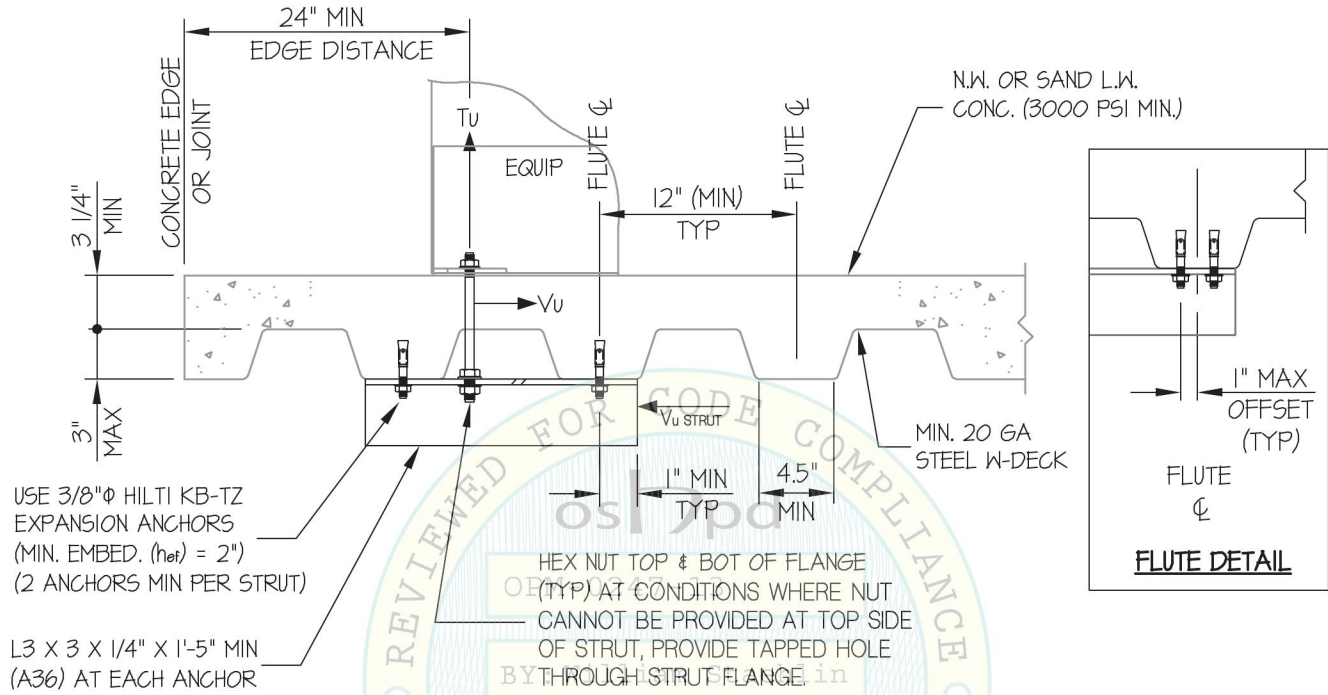

MIN STEEL DECK REQUIREMENTS AND STRUT DETAIL

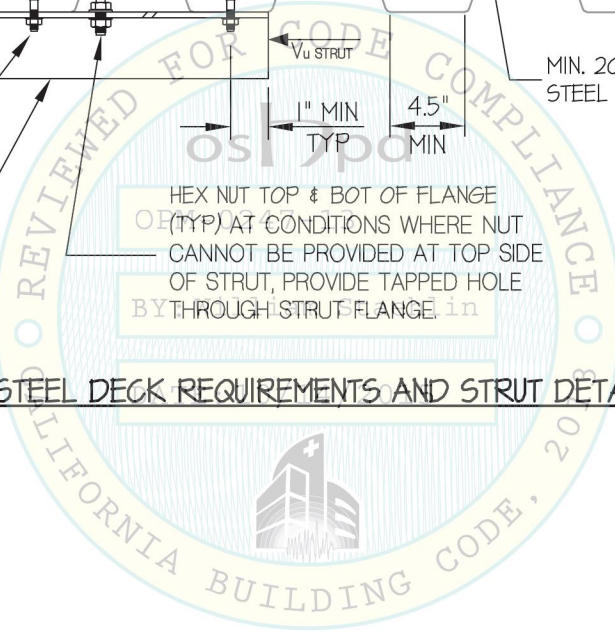

Jonathan Roberson

REGISTERED PROFESSIONAL ENGINEER
JONATHAN ROBERSON
No. 4197
EXP. 6-30-2016
10/6/15
STRUCTURAL
STATE OF CALIFORNIA

PENTAIR

FREE-STANDING ENCLOSURE SINGLE & DUAL ACCESS

DES. **J. ROBERSON**

JOB NO. **11-1461**

DATE **10/6/15**

SHEET

17

OF **18** SHEETS

SEISMIC SUPPORTS & ATTACHMENTS

BRACKET DETAILS

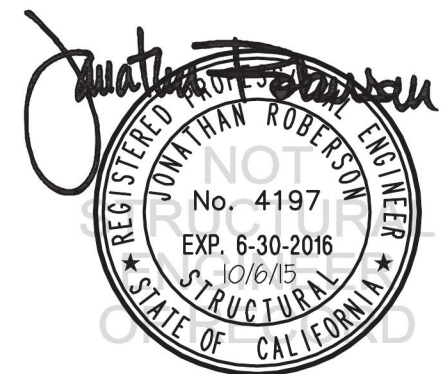
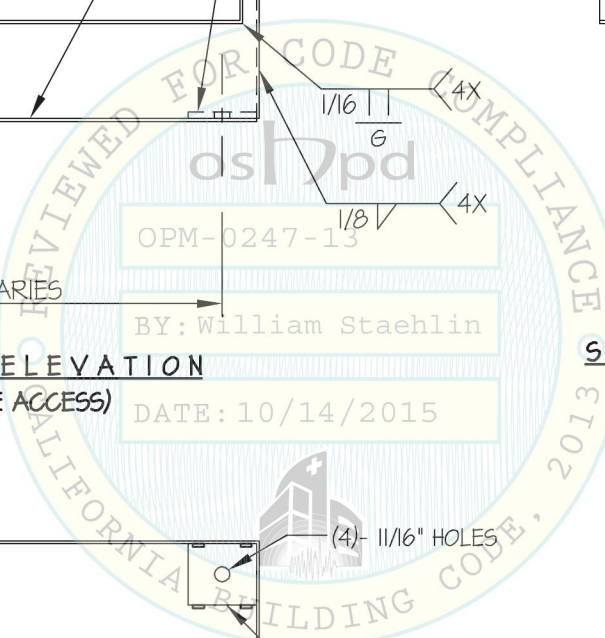
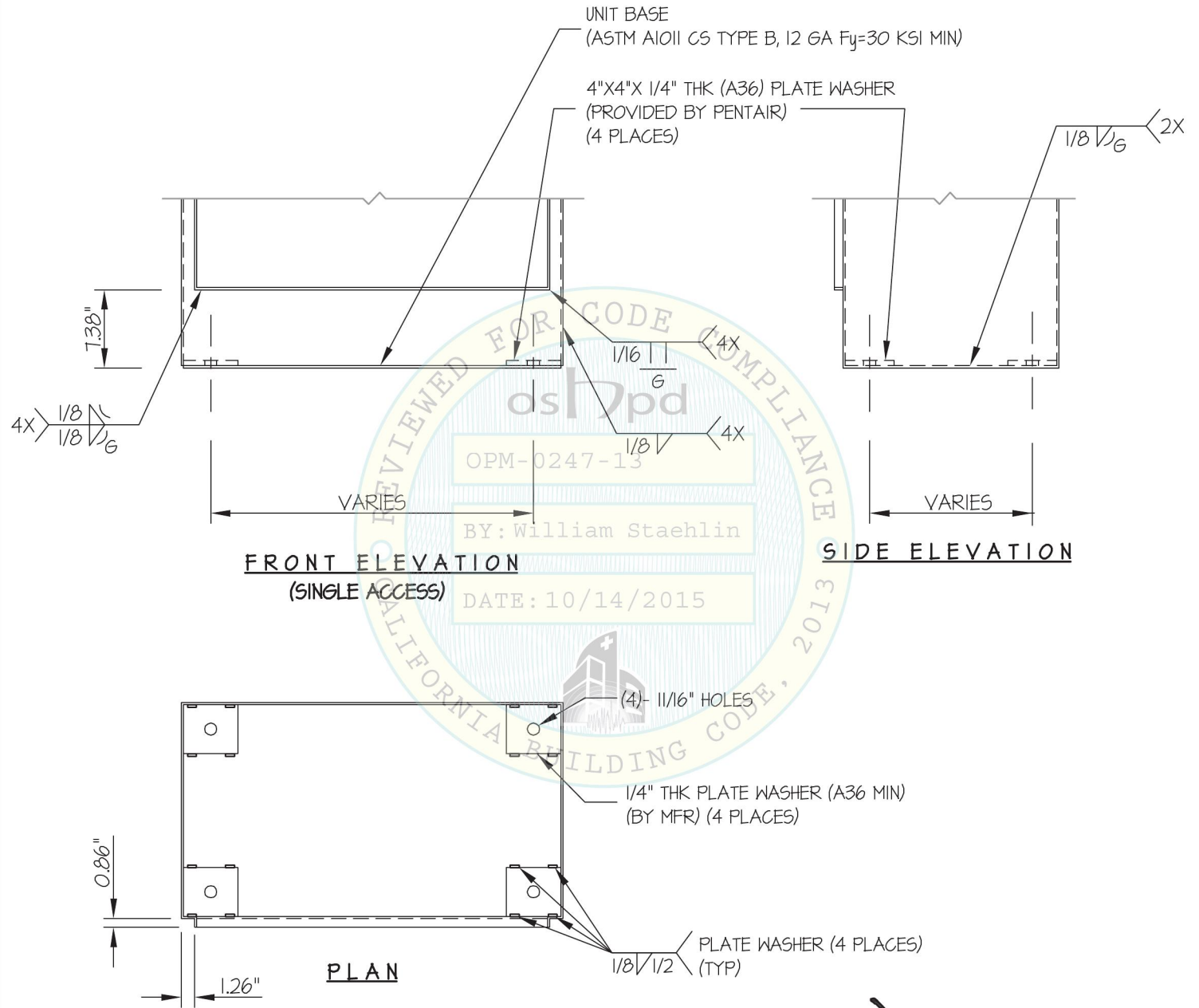

PENTAIR

FREE-STANDING ENCLOSURE SINGLE & DUAL ACCESS

DES. J. ROBERSON

JOB NO. 11-1461

DATE 10/6/15

SHEET

18

OF 18 SHEETS

SEISMIC SUPPORTS & ATTACHMENTS

BRACKET DETAILS

